

AYDE

MENFEZ PROFİLLERİ

DOORWAY PROFILES

20000

0,226 kg / mt

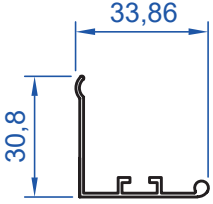

20001

0,207 kg / mt

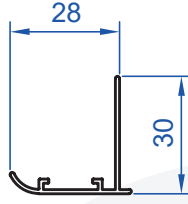

20002

0,273 kg / mt

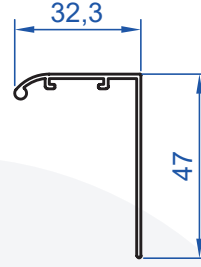

20003

0,225 kg / mt

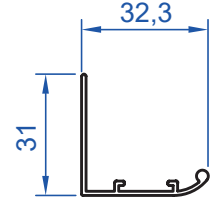

20004

0,238 kg / mt

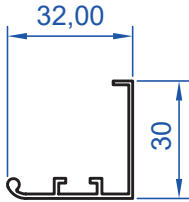

20005

0,140 kg / mt

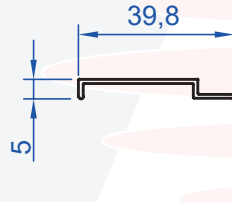

20006

0,122 kg / mt

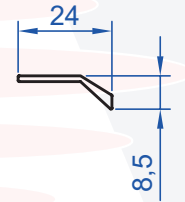

20007

0,178 kg / mt

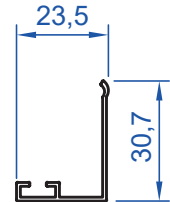

20008

0,257 kg / mt

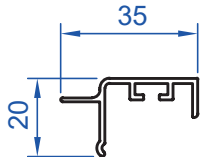

20009

0,403 kg / mt

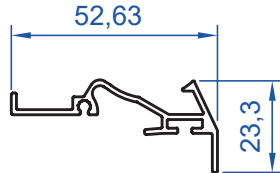

20010

0,569 kg / mt

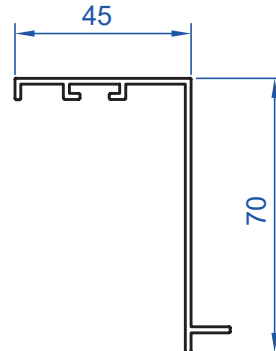

20011

0,453 kg / mt

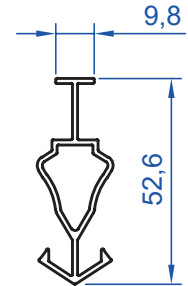

20012

0,419 kg / mt

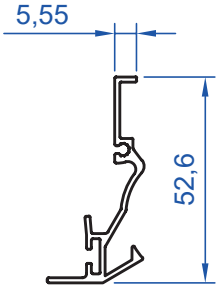

20013

0,157 kg / mt

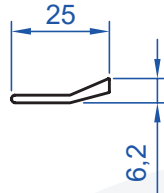

20014

0,524 kg / mt

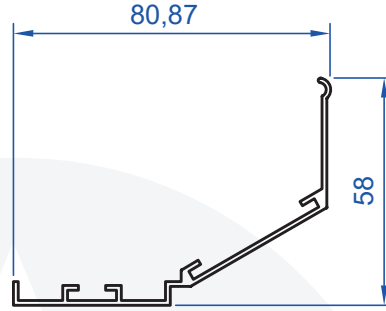

20015

0,212 kg / mt

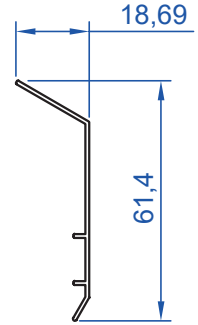

20016

0,413 kg / mt

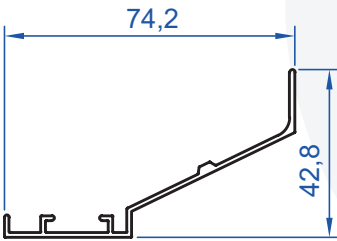

20017

0,252 kg / mt

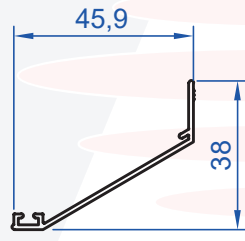

20018

0,545 kg / mt

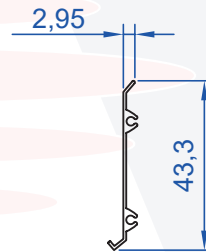

20019

0,245 kg / mt

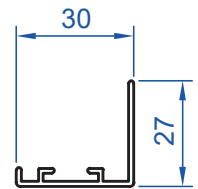

20020

0,245 kg / mt

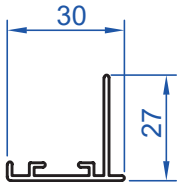

20021

0,309 kg / mt

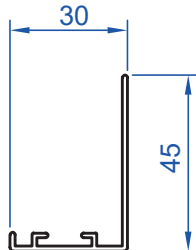

20022

0,282 kg / mt

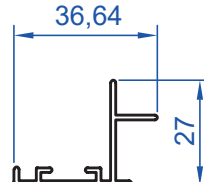

20023

0,233 kg / mt

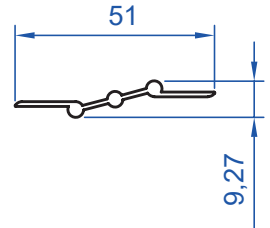

20024

0,157 kg / mt

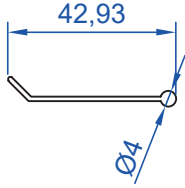

20025

0,452 kg / mt

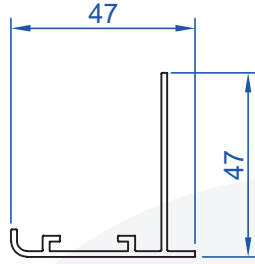

20026

0,303 kg / mt

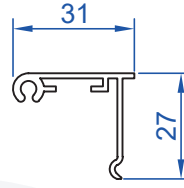

20027

0,211 kg / mt

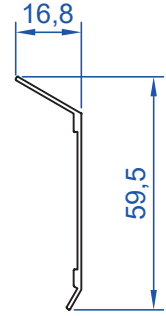

20028

0,479 kg / mt

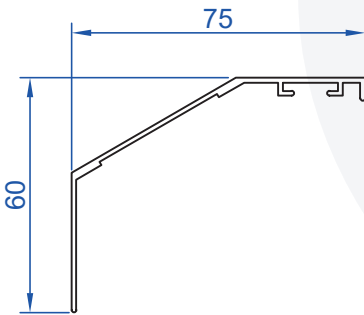

20029

0,841 kg / mt

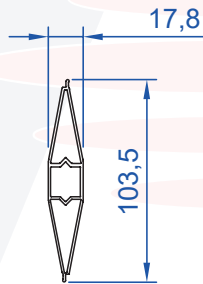

20030

0,084 kg / mt

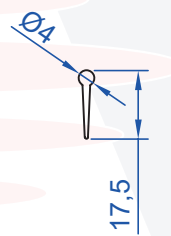

20031

0,091 kg / mt

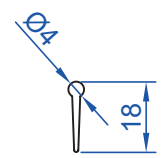

20032

1,204 kg / mt

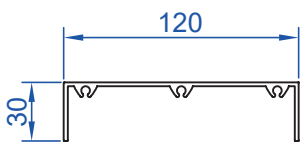

20033

0,302 kg / mt

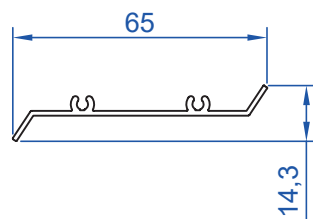

20034

0,126 kg / mt

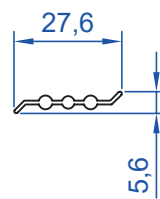

20035

0,313 kg / mt

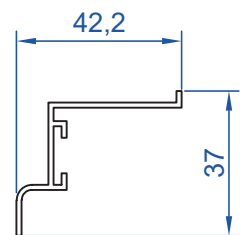

20036

0,235 kg / mt

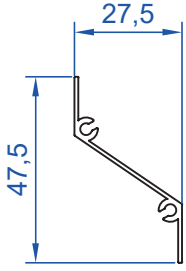

20037

0,383 kg / mt

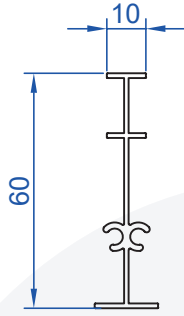

20038

0,578 kg / mt

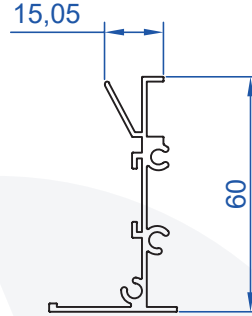

20039

0,102 kg / mt

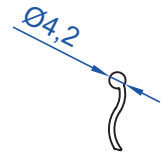

20040

0,346 kg / mt

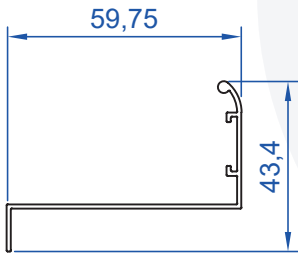

20041

0,123 kg / mt

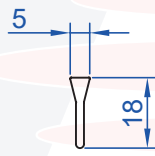

20042

0,310 kg / mt

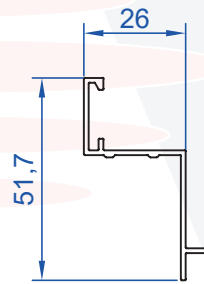

20043

0,373 kg / mt

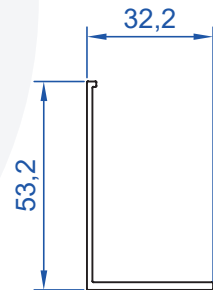

20044

0,287 kg / mt

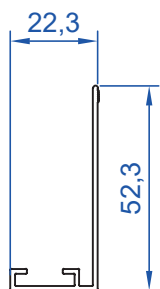

20045

0,131 kg / mt

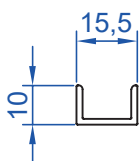

20046

0,173 kg / mt

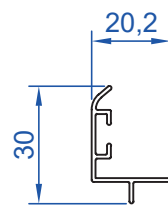

20047

0,279 kg / mt

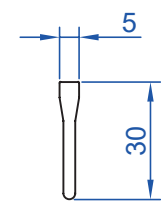

20048

0,136 kg / mt

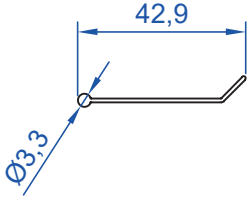

20049

0,592 kg / mt

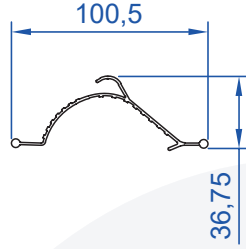

20051

0,541 kg / mt

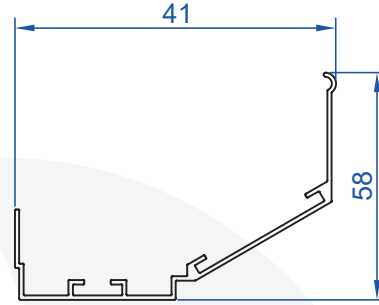

20052

0,280 kg / mt

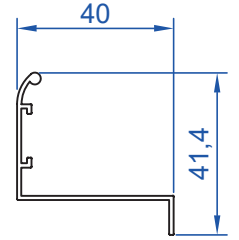

20053

0,274 kg / mt

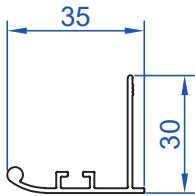

20055

0,316 kg / mt

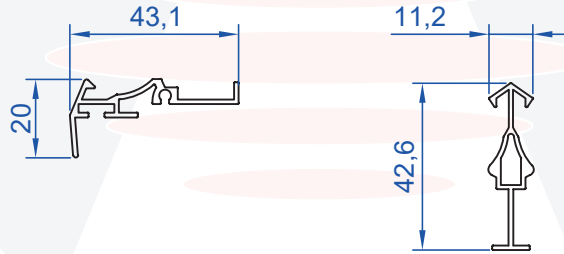

20056

0,296 kg / mt

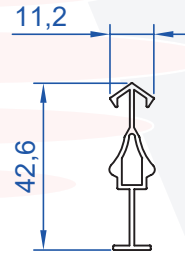

20057

0,665 kg / mt

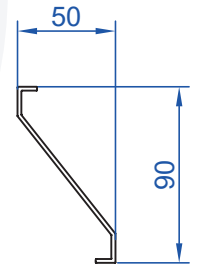

20058

0,237 kg / mt

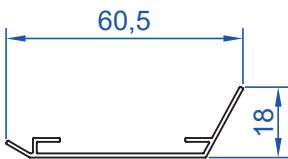

20059

0,344 kg / mt

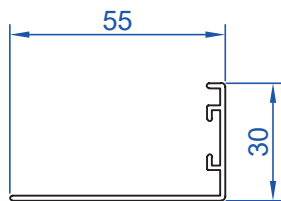

20060

0,169 kg / mt

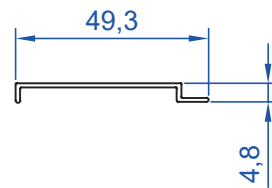

20061

0,108 kg / mt

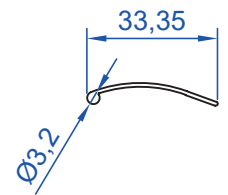

20062

0,278 kg / mt

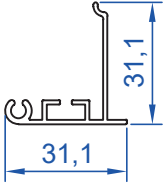

20063

1,390 kg / mt

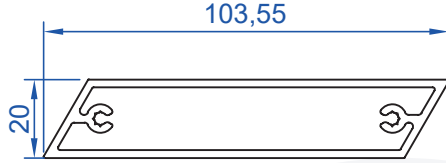

20064

0,293 kg / mt

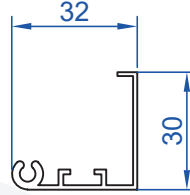

20065

0,286 kg / mt

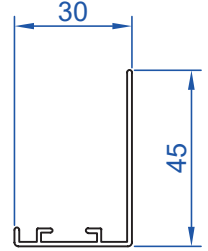

20066

0,222 kg / mt

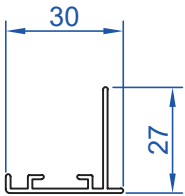

20067

0,219 kg / mt

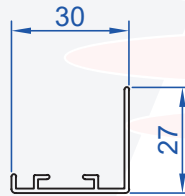

20068

0,489 kg / mt

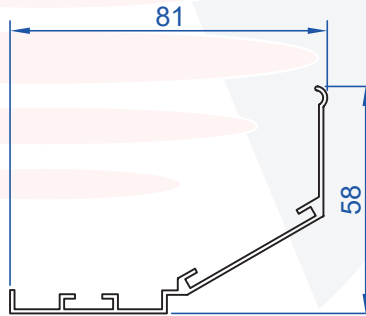

20069

0,286 kg / mt

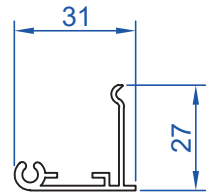

20070

0,075 kg / mt

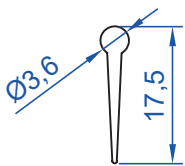

20071

0,078 kg / mt

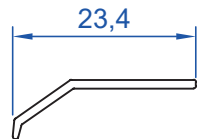

20072

0,517 kg / mt

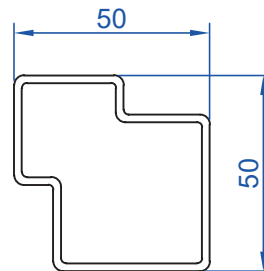

20073

0,440 kg / mt

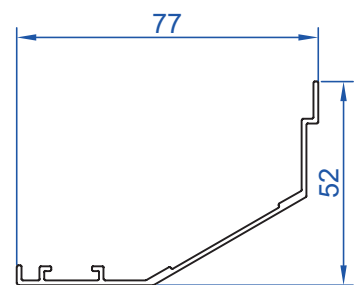

20074

0,402 kg / mt

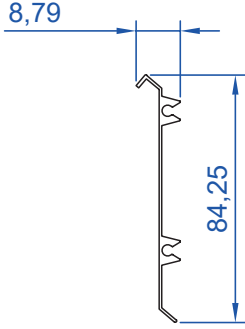

20075

0,590 kg / mt

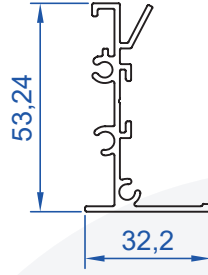

20076

0,427 kg / mt

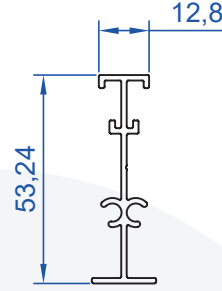

20077

1,262 kg / mt

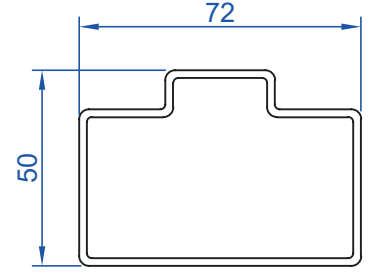

20078

0,071 kg / mt

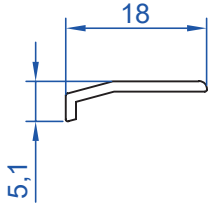

20079

0,078 kg / mt



20080

0,107 kg / mt

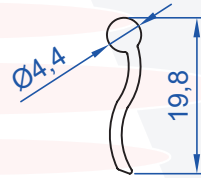

20081

0,779 kg / mt

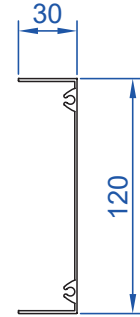

20082

0,482 kg / mt

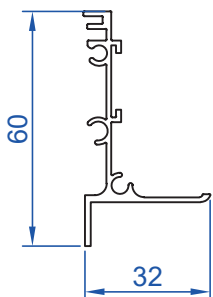

20083

0,201 kg / mt

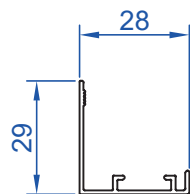

20084

0,264 kg / mt

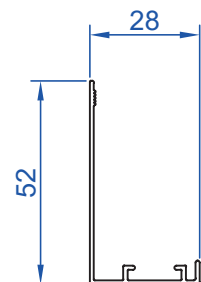

20085

0,478 kg / mt

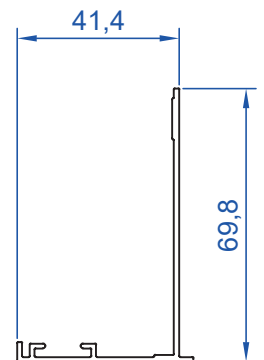

20086

0,257 kg / mt

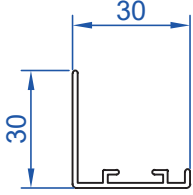

20087

0,225 kg / mt

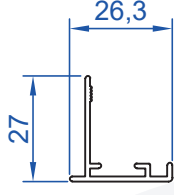

20088

0,435 kg / mt

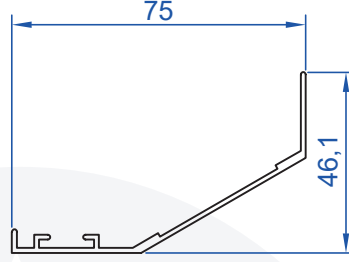

20089

0,493 kg / mt

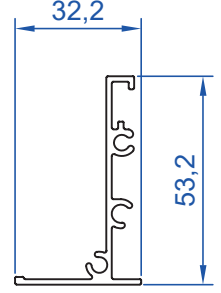

20090

0,494 kg / mt

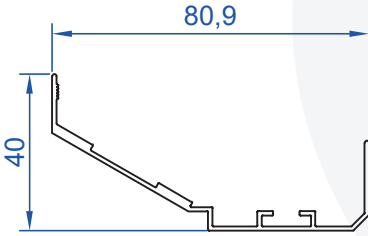

20091

0,458 kg / mt

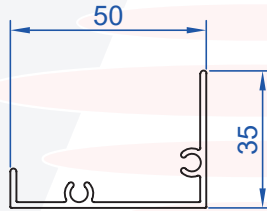

20092

0,570 kg / mt

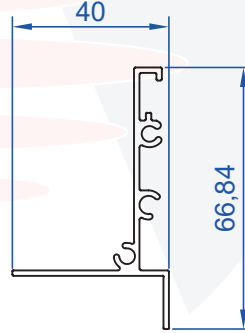

20050

0,108 kg / mt

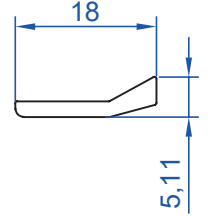

20094

0,477 kg / mt

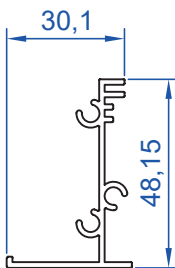

20095

0,450 kg / mt

